

---

# Facilities Study Report

IR 597 – 36 MW Wind Farm – Mersey Wind Phase 1

---

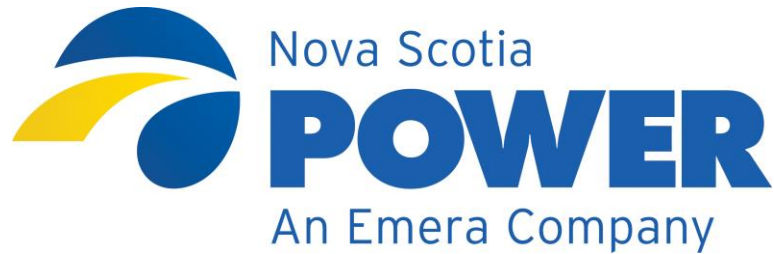

## **Facilities Study Report**

### **IR-597**

### **36 MW Mersey Wind Phase 1**

Prepared by  
Tim Leopold, P.Eng.

February 27, 2023

---

# Facilities Study Report

IR 597 – 36 MW Wind Farm – Mersey Wind Phase 1

---



## EXECUTIVE SUMMARY

This project provides for the establishment of a 138 kV system interconnection for a 36 MW wind generation facility (IR-597) located in Queens County, Nova Scotia to Nova Scotia Power Inc (NSPI) 138kV transmission substation 50W - Milton.

The Point of Interconnection (POI) for IR-597 will be at 50W-Milton Substation via a 138kV single breaker terminal. A new 138kV transmission line (L-6554) will be required from 50W-Milton to the Interconnection Customer's substation (112W-Mersey Wind). The Point of Change of Ownership (PCO) will be at the new line termination point in the Interconnection Customer's substation. The Point of Interconnection and the Point of Change of Ownership between NSPI and the Interconnection Customer are labelled on the Interconnection Overview diagram provided in Appendix B.

The 50W-Milton substation will be modified to accommodate the interconnection of IR-597. These modifications include building a new 138kV breaker terminal, relocation existing 138kV line L-6024 to the new terminal and using the terminal vacated by L-6024 for a new 138kV line to the Interconnection Customers' substation. The transmission facilities associated with this interconnection request will be sized to accommodate the planned future site expansion associated with IR-675 Mersey Wind II.

Developmental Plan View and One Line drawings of the proposed 50W-Milton Layout are provided in Appendix C.

The new 112W-Mersey Wind substation will be connected to NSPI's 50W-Milton Substation via a new 6.8km 138kV transmission line L-6554. The proposed routing provided by the Interconnection Customer for the new transmission line is shown in Appendix E-1. An alternate route was identified during the Facilities Study and both route options have been reviewed and addressed in the study report. The alternative route is shown in Appendix E-2.

The new transmission line will be a 138kV wood pole H-Frame construction with 556 ACSR conductor and overhead shield wires. One of the shield wires will include optical fibres for protection telecommunications to the Interconnection Customer's substation 112W-Mersey Wind.

The new system connection will include modifications and additions to the protection and control (P&C) schemes at 50W-Milton. The addition of protection relays, Supervisory Control and Data Acquisition (SCADA), revenue metering, and telecommunications will also be required at the Interconnection Customers' substation 112W-Mersey Wind. The Revenue Class 138kV voltage and current transformers required for revenue metering at 112W-Mersey Wind will be supplied and installed by the Interconnection Customer as per

---

# Facilities Study Report

IR 597 – 36 MW Wind Farm – Mersey Wind Phase 1

---



NSPI specification.

NSPI will require space and unrestricted access in the Interconnection Customer’s substation control building for the protection equipment at 112W-Mersey Wind, the Remote Terminal Unit (RTU) and the communications terminal equipment. This will require space for two standard size free-standing cabinets.

The total estimated cost to construct the Transmission Provider’s interconnection facilities is \$4,505,959 based on the proposed route (Option A) submitted by the Interconnection Customer. An alternate transmission line route was also considered as part of the Facilities Study. The total estimated cost utilizing the alternate route (Option B) is \$4,901,447.

The Interconnection Customer’s initial proposed commercial operation date was December 15, 2023. NSPI were notified on February 21, 2023 that the targeted commercial operation date had changed to June 30, 2024. Based on reasonable timelines for detailed design, procurement, and construction, the proposed commercial operation date cannot be met by NSPI. NSPI are projecting completion of the required interconnection facilities by Q4, 2024. An overall estimated project timeline and schedule is provided in Appendix G.

# Facilities Study Report

IR 597 – 36 MW Wind Farm – Mersey Wind Phase 1



## Table of Contents

<b>EXECUTIVE SUMMARY</b> -----	<b>ii</b>
<b>1.0 INTRODUCTION</b> -----	<b>1</b>
1.1 PROJECT OWNERSHIP AND RESPONSIBILITIES .....	1
1.2 ESTIMATED COST .....	2
1.3 PROJECT SCHEDULE .....	2
<b>2.0 SCOPE OF WORK BY NSPI</b> -----	<b>3</b>
2.1 DEVELOPMENTAL ONE LINE AND PRIMARY EQUIPMENT .....	3
2.2 MODIFICATIONS AT 50W-MILTON SUBSTATION .....	3
2.3 TRANSMISSION LINE L-6554 .....	5
2.4 PROTECTION AND CONTROL .....	9
2.5 SUPERVISORY CONTROL AND DATA ACQUISITION / REMOTE TERMINAL UNIT.....	10
2.6 TELE-COMMUNICATIONS.....	10
2.7 REVENUE METERING.....	10
2.8 STATION SERVICE .....	11
<b>3.0 SCOPE OF WORK BY INTERCONNECTION CUSTOMER</b> -----	<b>12</b>
3.1 BASIC ONE LINE – 112W – MERSEY WIND .....	12
3.2 TRANSMISSION LINE L-6554 .....	12
3.3 GENERATION INTERCONNECTION SUBSTATION .....	12
3.4 PROTECTION AND CONTROL - ACCESS AND INPUTS .....	13
3.5 STATION SERVICE .....	13
3.6 PERMITS, APPROVALS, AND STANDARDS .....	14
<b>4.0 DESIGN AND CONSTRUCTION</b> -----	<b>15</b>
<b>5.0 TPIF AND STAND ALONE UPGRADE CATEGORIZATION</b> -----	<b>16</b>
<b>6.0 PROJECT SCHEDULE</b> -----	<b>18</b>
<b>7.0 COST ESTIMATE</b> -----	<b>19</b>
<b>8.0 COMMISSIONING/OPERATIONS</b> -----	<b>20</b>
<b>APPENDIX A – INTERCONNECTION FACILITIES STUDY AGREEMENT</b> -----	<b>21</b>
<b>APPENDIX B – INTERCONNECTION OVERVIEW DIAGRAM</b> -----	<b>29</b>
<b>APPENDIX C – DEVELOPMENTAL 50W MILTON DRAWINGS</b> -----	<b>30</b>
<b>APPENDIX D – INTERCONNECTION CUSTOMER SUBSTATION ONE LINE</b> -----	<b>32</b>
<b>APPENDIX E – TRANSMISSION LINE ROUTE OPTIONS</b> -----	<b>33</b>
<b>APPENDIX F – COST ESTIMATE</b> -----	<b>35</b>
<b>APPENDIX G – PRELIMINARY PROJECT SCHEDULE</b> -----	<b>37</b>
<b>APPENDIX H – REVENUE METERING</b> -----	<b>38</b>
<b>APPENDIX I – SCADA POINTS LIST</b> -----	<b>40</b>
<b>APPENDIX J – MINUTES OF FACILITIES STUDY REVIEW MEETING</b> -----	<b>41</b>

---

# Facilities Study Report

IR 597 – 36 MW Wind Farm – Mersey Wind Phase 1

---



## 1.0 INTRODUCTION

This Facilities Study Report is based on the Standard Generation Interconnection Procedures and System Impact Study (SIS) below:

System Impact Study Report  
Report GIP-IR597-SIS-R0  
By Bryce Clothier, P.Eng.

The SIS describes the facilities required to connect the generating facility to NSPI's transmission system. It also addresses short circuit, power factor, steady state and stability analysis, voltage flicker and power flow issues. It provides an overview of the scope of work to be completed and provides direction to this Facilities Study (FAC).

### 1.1 Project Ownership and Responsibilities

Ownership, maintenance, and other commercial operation arrangements will be covered separately in a future Generation Interconnection Agreement (GIA) between NSPI and the Interconnection Customer.

Following NSPI system naming standards, the new generation interconnection substation will be labeled 112W-Mersey Wind and the new 138kV line from 50W-Milton to 112W-Mersey Wind will be labeled L-6554.

Ownership of the infrastructure associated with 112W-Mersey Wind generating substation is based on the Point of Change of Ownership shown on the Interconnection Overview Diagram in Appendix B. NSPI (as the transmission provider) will own the new breaker terminal at 50W-Milton and the new 138 kV line L-6554 from the 50W-Milton Substation to the dead-end structure located within customer's substation 112W.

All communication systems infrastructure between NSPI's 50W-Milton Substation and the new generation interconnection facility 112W-Mersey Wind required for control and monitoring of the facility will be owned by NSPI. This includes the SCADA RTU and telecommunications equipment located at the generation interconnection substation 112W-Mersey Wind.

NSPI will also own the revenue metering located in the generation interconnection substation 112W-Mersey Wind.

---

# Facilities Study Report

IR 597 – 36 MW Wind Farm – Mersey Wind Phase 1

---



## 1.2 Estimated Cost

The total estimated cost to construct the Transmission Provider’s interconnection facilities is \$4,505,959 based on the proposed route (Option A) submitted by the Interconnection Customer. An alternate transmission line route was also considered as part of the Facilities Study. The total estimated cost utilizing the alternate route (Option B) is \$4,901,447.

The cost estimates are based on the scope of work outlined in Section 2.0 of this Facilities Study Report. The customer will be responsible to pay NSPI for the actual incurred cost associated with this project, be it higher or lower than the cost estimates provided.

The cost estimate in this report is valid for one-hundred eighty (180) days.

The project cannot commence until the customer delivers to NSPI the balance of the cost estimate for the project in a form acceptable to NSPI, as per the terms of the GIA.

## 1.3 Schedule

The estimated project duration includes all scope of work required for the transmission interconnection as outlined in Section 2.0.

The Interconnection Customer’s initial proposed commercial operation date was December 15, 2023. NSPI were notified by the Interconnection Customer on February 21, 2023 that the targeted commercial operation date had changed to June 30, 2024. Based on estimated timelines for detailed design, procurement, and construction, the proposed commercial operation date cannot be met by NSPI. NSPI are projecting completion of the required interconnection facilities by Q4, 2024.

An outline of major project milestones is provided in Section 5.0 and a preliminary project schedule outlining the major components of this project is provided in Appendix G.

---

# Facilities Study Report

IR 597 – 36 MW Wind Farm – Mersey Wind Phase 1

---



## 2.0 SCOPE OF WORK BY NSPI

The scope of this Facilities Study is limited to providing the necessary designs, equipment, labor, and services required to interconnect the new IR-597 Mersey Wind 36MW generating facility to the POI at NSPI's Substation 50W-Milton. A new 138kV transmission line will be constructed from 50W-Milton to the customer's interconnection substation 112W-Mersey Wind. The transmission facilities associated with this interconnection request will be sized to accommodate the planned future site expansion associated with IR-675 Mersey Wind II.

This report will also cover the equipment required by NSPI at the Transmission Provider's Interconnection Facilities (equipment located on the Interconnection Customer's side of the Point of Change of Ownership and within the Interconnection Customer's Substation).

### 2.1 Developmental One Line and Primary Equipment

An interconnection overview diagram of the IR-597 Mersey Wind interconnection is provided in Appendix B which identifies the Point of Interconnection (POI) and the Point of Change of Ownership (PCO). The Developmental One Line diagram of the modifications at 50W-Milton is provided in Appendix C-1. A developmental Plan View of the modifications at 50W-Milton is provided in Appendix C-2.

### 2.2 Modifications at 50W-Milton Substation

A new 138kV breaker terminal will be established at 50W-Milton. To accommodate the new 138kV transmission line L-6554 with minimal line crossovers, the existing line L-6024 will be relocated to the new breaker terminal and L-6554 will be terminated at the breaker terminal vacated by L-6024.

#### 2.2.1 50W- Milton Structures and Foundations

The existing A-Frame dead-end structure on L-6024 is not designed to accommodate an adjacent line termination by adding a third leg. The existing structure will therefore be replaced with a new 3-leg A-Frame dead-end to accommodate the new line L-6554 and existing line L-6024.

*Note: A separate single A-Frame dead-end may be possible depending on the*

---

# Facilities Study Report

IR 597 – 36 MW Wind Farm – Mersey Wind Phase 1

---



*existing footing configurations. This option will be explored during detailed design as this analysis exceeds the normal level of engineering completed for a Facilities Study.*

Concrete foundations and steel support structures will be installed for:

- 1 – 138kV 3-leg A-Frame double dead-end
- 2 – 138kV low rigid bus supports
- 2 – 138kV disconnect supports
- 1 – 138V three phase surge arrester support

Concrete foundations only will be installed for:

- 1 – 138kV dead tank circuit breaker

## 2.2.2 Grounding and Conduit

The existing substation ground grid will be evaluated to ensure safe operation for updated fault levels and step/touch potentials. All new structures and equipment will be tied into the existing substation ground grid. Conduits will be added as required to accommodate the new control cable additions.

## 2.2.3 Primary Equipment and Layout

The developmental substation layout for 50W-Milton is provided in Appendix C-2. All equipment shall conform with Nova Scotia Power standard equipment specifications.

New primary equipment will consist of:

- Circuit Breaker 50W-624
  - 145kV, 1200A, 31.5kA Dead Tank circuit breaker c/w 12/8/3/200-5A multi-ratio current transformers
- Disconnects 50W-624A and 624B/624E
  - 145kV, 1200A, 40kA, 650kV BIL vertical break disconnect with a manual operator.
  - 624B will also include an integral interlocked grounding switch 624E.
- 138 kV Line Arresters (3)
  - Station Type, Metal Oxide, 145kV, 98kV MCOV

The new 138kV breaker terminal will be installed adjacent to the existing terminal L-6024 on the south side. L-6024 will then be relocated to the new terminal. The new transmission line L-6554 will then be terminated at the breaker bay vacated by L-6024.



---

# Facilities Study Report

IR 597 – 36 MW Wind Farm – Mersey Wind Phase 1

---



## 2.3 Transmission Line L-6554

The new 112W-Mersey Wind substation will be connected to NSPI's 50W-Milton Substation via a new 6.8km 138kV transmission line L-6554. The proposed routing provided by the Interconnection Customer for the new transmission line is shown in Appendix E-1. An alternate route was identified during the Facilities Study and both route options have been reviewed and addressed in the study report. The optional route is shown in Appendix E-2

The new transmission line will be a 138kV wood pole H-Frame construction with 556 ACSR conductor and overhead shield wires. One of the shield wires will include optical fibres for protection telecommunications to the Interconnection Customer's substation 112W.

The Interconnection Customer is required to acquire all easements and permitting associated with the accepted Transmission Line route. The route options noted below, and associated cost estimates assume that the Interconnection Customer provides a cleared right of way with all easements and permits in place.

The transmission line routes may pass through archaeological sensitive sites. Any stakeholder engagement, including First Nations consultation, will need to be considered as part of the overall design and is the responsibility of the Interconnection Customer. NS Power shall not be responsible for delays or cost increases associated with unforeseen stakeholder accommodations.

# Facilities Study Report

IR 597 – 36 MW Wind Farm – Mersey Wind Phase 1



## 2.3.1 Original Proposed Line Route Option (Option A)

Based on the location provided for the Interconnection Customers' proposed substation and the proposed routing shown in Appendix E-1, the new transmission line will be approximately 6.8km from the POI at 50W-Milton Substation to the Interconnection Customer's Substation 112W-Mersey Wind.

The new L-6554 line will terminate to the L6024-str002 dead-end and reuse the existing section of the line L6024 to connect to the substation. The first two structures of L6024 and L6020 will be shifted/relocated south to provide the required minimum distance between the adjacent lines (see sketch 1). It is assumed that the 69 kV lines L5541 and L5540 won't need to be relocated.



Sketch 1: Lines modification close to the 50W substation

# Facilities Study Report

IR 597 – 36 MW Wind Farm – Mersey Wind Phase 1



## 2.3.2 Alternate Line Route Option (Option B)

An alternate routing line routing was considered based on the location provided for the Interconnection Customers' proposed substation and the alternate proposed routing shown in Appendix E-2. The new transmission line would be approximately 6.7km from the POI at 50W-Milton Substation to the Interconnection Customer's Substation 112W.

The same relocation work around the substation 50W as noted in sketch 1 for Option A would still be required. From the L6024-str002 tap, instead of running west, the new L6554 will continue south, running parallel to L6024 and L6020 and sharing the same corridor with required ROW extension. Then, it will join the Option A routing as shown in the sketch 2. The line will cross the Mersey River with two structures needed to be installed on the island. Constructing and transporting material to the island will be challenging and impacts the overall construction cost estimate.

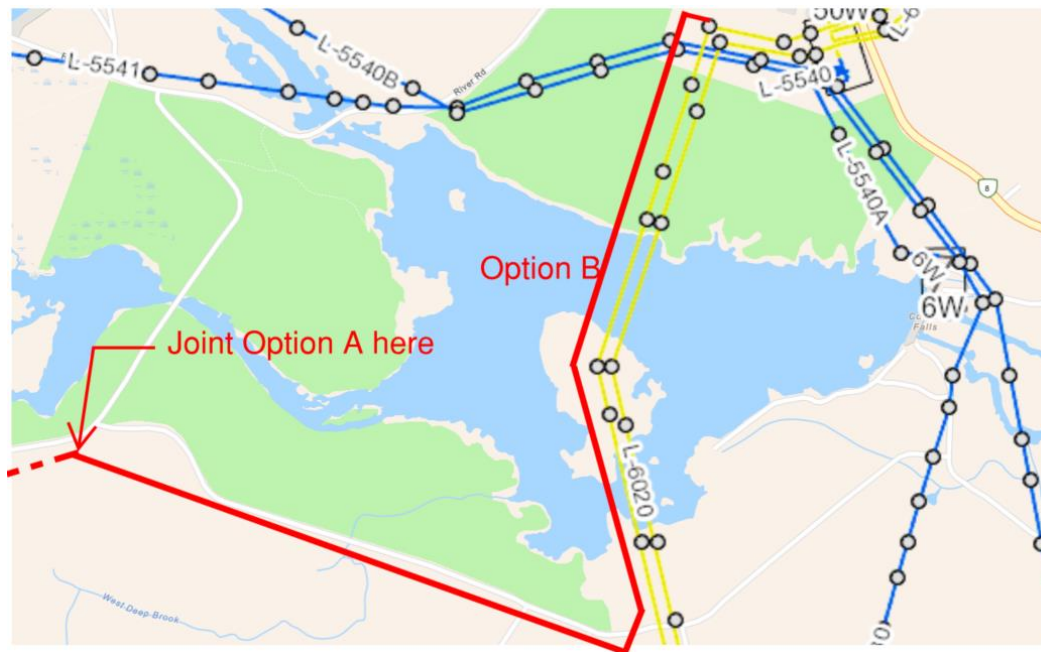

Sketch 2: Option B routing

# Facilities Study Report

IR 597 – 36 MW Wind Farm – Mersey Wind Phase 1



## 2.3.3 Transmission Line Characteristics and Option Summary:

Single conductor (Dove 556 ACSR 26/7)

OHWG (Overhead Ground Wire): 7/16" EHS Grade 180

OPGW (Optical Ground Wire)

Ruling Span: 200 m

Structure types:

- Suspension: H-Frame: 65'-H2
- Angle/Dead-end: 3 Poles: 65'-H2
- 2 Fiber Reinforced Polymer (FRP) structures are considered for Option B for the island crossing.
- A total of 4 structure types is projected to be required for this project.

Structure Type	Option A	Option B
Length (km)	6.8	6.7
Total structure number	38	39
Tangent H-Frame Structure 138-TH-2(0)	22	19
Light Angle 3 Poles structure 138-AL-3(BR) (0)	3	4
Heavy Angle 3 Poles structure 138-DHA-3(0)	7	6
Tangent Dead-End 3 Poles Structure 138-DT-3 (0)	2	4
RFP structures (Island)	-	2
L6024 230 kV structure relocation	2	2
L6020 structure relocation	2	2

---

# Facilities Study Report

IR 597 – 36 MW Wind Farm – Mersey Wind Phase 1

---



## 2.4 Protection and Control

Protection upgrades to the existing line protection equipment are required at accommodate the addition of IR-597.

At 50W-Milton substation, the following scope of work is required:

- The existing fault recorder panel will be removed to make room for a new line protection panel P14.
- Panel modifications to bus B4 protection panel P9, breaker backup (BBU) panel P22 and control panel P15 will be required to accommodate the new 138kV breaker terminal 50W-604 to be used for L-6024.
- A new panel P14 for L-6024 protection will be installed along with new 50W-604 breaker prior to line L-6024 shift to the new breaker bay.
- After L-6024 is shifted to the new 50W-604 breaker, a new panel for L-6554 protection will be installed in place of the old L-6024 panel as P20.
- Breaker 50W-624 will supply the new transmission line L-6554, a single 138 kV line to the Mersey Wind site.
- The new transmission line L-6554 will have overhead ground wire (OHGW) continuous for the line length with optical ground wire (OPGW) as one of the shield wires. This will provide the communications path from 50W-Milton to 112W-Mersey Wind.
- The primary line protection for L-6554 and L-6024 will utilize a SEL-311L relay.
- Secondary line protection for L-6554 to be GE L90 relay.
- Both primary and secondary communications for L-6554 line current differential will be routed onto the OPGW.
- Backup protection (for fiber communications failure) for L-6554 will come from line distance elements in the primary and secondary relays.
- An additional scanner card will be added to the existing sequence of events recorder (SER) to accommodate the additional alarms.

At the Interconnection Customer's substation 112W-Mersey Wind, NSPI will require space and unrestricted access in the substation control building for two protection and control panels. One panel will contain the line protection relays and the second panel will house the Remote Terminal Unit (RTU), a 48V battery and charger, and the communications equipment.

NSPI will own, supply, and install the protection and control equipment.

NSPI shall require the Interconnection Customer to supply three phase inputs

---

# Facilities Study Report

IR 597 – 36 MW Wind Farm – Mersey Wind Phase 1

---



from the 138kV breaker current transformers and the 138kV bus potential transformers. NSPI shall also require access to the 138kV breaker tripping circuit for line protection trip.

## **2.5 Supervisory Control and Data Acquisition / Remote Terminal Unit**

The anticipated Supervisory Control and Data Acquisition (SCADA) points are listed in Appendix G. Please note that the final list of SCADA points will be confirmed during detailed design.

At 50W-Milton, any new SCADA points will be added to the existing RTU. An additional scanner card will be added to the existing Sequence of Events Recorder (SER) to accommodate the additional alarms.

At 112W-Mersey Wind substation, the Remote Terminal Unit (RTU) will be installed in a common panel with the communications equipment as described in section 2.3. The RTU will come with a 48V backup battery and charger. NSPI will own, supply, and install the RTU. A dedicated 120V AC station service supply will be required to be supplied by the Interconnection Customer to supply the battery charger.

## **2.6 Tele-Communications**

An Optical Ground Wire (OPGW) shall be installed as part of the new transmission line L-6554 from 50W-Milton to 112W-Mersey Wind to provide a communications path for telecontrol and protection. The communications equipment will be in a common panel with the RTU as described in section 2.4. NSPI will own, supply, and install the fibre optic terminations and associated communications equipment.

## **2.7 Revenue Metering**

A 138kV revenue metering system, owned by NSPI, shall be installed at the Interconnection Customer's substation.

The 138kV revenue class current and voltage transformers will be supplied and installed by the Interconnection Customer complete with supporting structures, test switch, and meter base as per Nova Scotia Power metering standard STD 5.12 (attached as Appendix H: Revenue Metering).

---

# Facilities Study Report

IR 597 – 36 MW Wind Farm – Mersey Wind Phase 1

---



The revenue metering class potential and current transformers shall not be embedded in any other piece of equipment and shall be certified by Measurement Canada for three element metering. Nova Scotia Power shall provide the technical specifications for the required current and voltage transformers to the Interconnection Customer.

Nova Scotia Power will install the revenue meter at the Interconnection Customer's substation once the commissioning is complete and the system is ready for energization.

## **2.8 Station Service**

NSPI will require a dedicated 120V AC circuit from Interconnection Customer's 112W-Mersey Wind substation control building AC distribution panel to supply the NSPI owned protection and control panel.

---

# Facilities Study Report

IR 597 – 36 MW Wind Farm – Mersey Wind Phase 1

---



## **3.0 SCOPE OF WORK BY INTERCONNECTION CUSTOMER**

### **3.1 Basic One Line – 112W – Mersey Wind**

A Basic One Line diagram of the Interconnection Customer’s substation 112W-Mersey Wind (provided by the Interconnection Customer) is shown in Appendix D. The substation is configured with provision for a future phase II. The Interconnection Facility consists of eight, 4.5MW wind energy convertors totaling 36MW split evenly in two collector circuits. The generator step-up transformer is 30/40/50 MVA, 138kV (wye) to 34.5kV (wye).

### **3.2 Transmission Line L-6554**

The Interconnection Customer is responsible for providing NSPI with an easement and access rights for the required right-of-way (ROW) for the transmission line from 50W-Milton to the Interconnection Customer’s substation 112W-Mersey Wind and acquiring all construction permits.

Two options for the proposed routing of the new transmission line were provided in section 2.3. The Interconnection Customer shall confirm the final routing before finalizing the Interconnection Agreement.

NSPI’s standard for 138 kV ROW is 30 m (15 m on each side of the center phase in an H-Frame design). The easements and access plans shall allow NSPI the right to access, construct, operate, maintain, and repair the transmission line.

Vegetation clearing of the transmission line right of way shall be completed by the Interconnection Customer prior to construction of the line.

### **3.3 Generation Interconnection Substation**

The layout and electrical design of the Interconnection Customer’s substation shall be the responsibility of the Interconnection Customer.

The substation will have a basic layout with the substation’s transmission line entering the substation through a 138 kV group-operated disconnect switch used principally to isolate the substation from the transmission system and for maintenance and repairs on the transmission line. The substation will be metered on the 138 kV bus via a dedicated revenue metering system owned by NSPI. The



---

# Facilities Study Report

IR 597 – 36 MW Wind Farm – Mersey Wind Phase 1

---



power transformer (112W-T61) will be three phase and step-up the generator bus voltage from 34.5 kV to the 138kV system voltage. The low side of the transformer will consist of two (2) generation collector circuit bays and a substation station service supply.

The substation will have one (1) 138 kV line terminal dead-end structure for terminating the transmission line L-6554.

The Interconnection Customer shall be responsible to supply and install the revenue metering system to Nova Scotia Power specifications as outlined in Section 2.7.

The Interconnection Customer shall provide the Protection and Instrumentation One Line and Substation Layout drawings to NSPI for review to ensure protection & control systems and physical line tap arrangements align with NSPI designs.

The facility must meet NSPI's Transmission System Interconnection Requirements (TSIR) as published on the NSPI OASIS site.

## **3.4 Protection and Control - Access and Inputs**

The Interconnection Customer shall provide space and unrestricted access in the Interconnection Customer's substation control building for NSPI's protection, communications, and control equipment as detailed in section 2.4, 2.5, and 2.6. The Interconnection Customer shall provide NSPI with the three phase inputs from the 138kV breaker current transformers and the 138kV bus potential transformers, access to the 138kV breaker tripping circuit, and all required SCADA points as outlined in Appendix G.

## **3.5 Station Service**

The Interconnection Customer shall provide a dedicated 120V AC circuit from Interconnection Customer's substation building AC distribution panel to supply the NSPI owned protection and control panel.

---

# Facilities Study Report

IR 597 – 36 MW Wind Farm – Mersey Wind Phase 1

---



## 3.6 Permits, Approvals, and Standards

The Interconnection Customer is responsible to obtain all permits and approvals, including First Nations agreements, required to construct the interconnection substation at 112W-Mersey Wind and the new transmission line L-6554 from 50W-Millton substation to 112W-Mersey Wind substation.

The Nova Scotia Electrical Inspection Act requires that electrical work be performed under permit. Contractors must take out permits for work at voltage levels below and above 750V – including work on customer owned substations. Plans must be submitted for review and all equipment must be approved by a recognized certification authority (CSA, ULC, etc.).

The customer facilities are subject to the minimum requirements of the latest edition of the Canadian Electrical Code, CSA C22.1, for the purpose of electrical inspection. The cost associated with acquiring wiring permits and the associated electrical inspections are the responsibility of the customer. No equipment will be connected or energized without authorization of the electrical inspector.

The interconnection substation installation will be subject to the review and acceptance by Nova Scotia Power to ensure coordination of the Nova Scotia Power and Interconnection Customer's scopes of work.

---

# Facilities Study Report

IR 597 – 36 MW Wind Farm – Mersey Wind Phase 1

---



## 4.0 DESIGN AND CONSTRUCTION

NSPI will be responsible for the engineering drawing production for all aspects of the scope of work described in Section 2.0 of this report. NSPI will also own, supply, and install this equipment including:

- Transmission line design and construction of a new 138kV transmission line (L-6554) from 50W-Milton Substation to the Interconnection Customer's Substation 112W-Mersey Wind.
- The new 138kV breaker terminal at 50W-Milton Substation including all associated substation modifications.
- The telecommunications system including the SCADA RTU.
- The protection and control design associated with the modifications at 50W-Milton and the NSPI protection relays at 112W-Milton Wind.

As per Article 5 of the Standard Interconnection and Operating Agreement (GIA), NSPI will be responsible for all aspects of Transmission Provider's Interconnection Facilities unless the schedule dates of construction are not acceptable to the Interconnection Customer. Article 5 of the GIA outlines options for the Interconnection Customer to take responsibility for design, procurement, and construction of Stand-Alone Upgrades. Section 5.0 of this FAC addresses the clarification of stand-alone facilities for this interconnection.

The construction work associated with this interconnection will require planned outages at 50W and to lines L-6024 and L-6020. Planned system outages must be coordinated with NSPI System Operations and will be restricted to light load conditions with hydro generation available.

---

# Facilities Study Report

IR 597 – 36 MW Wind Farm – Mersey Wind Phase 1

---



## 5.0 TPIF and STAND-ALONE UPGRADES CATEGORIZATION

In the event NSPI cannot meet the Interconnection Customer’s schedule expectation or as agreed in the terms of the Standard Generation Interconnection and Operating Agreement (GIA), the Interconnection Customer may take responsibility for design, procurement, and construction activities associated with NSPI owned assets as covered in Article 5.1.3 of the GIA.

These design, procurement, and construction activities are limited to upgrades deemed to be ‘Transmission Providers Interconnection Facilities (TPIF)’ or ‘Stand Alone Network Upgrades’, defined as:

*Transmission Provider's Interconnection Facilities shall mean all facilities and equipment owned, controlled, or operated by the Transmission Provider from the Point of Change of Ownership to the Point of Interconnection as identified in Appendix A to the Standard Generator Interconnection and Operating Agreement, including any modifications, additions or upgrades to such facilities and equipment.*

*Stand Alone Network Upgrades shall be defined as Network Upgrades that the Interconnection Customer may construct without affecting day-to-day operations of the Transmission System during their construction.*

In IR-597, there are no Stand-Alone Network Upgrades. The proposed 138kV radial line plus the line termination and breaker at the 50W-Milton Substation form part of the TPIF. As construction of some components of the TPIF will have an effect on the day-to-day operations of the transmission system, Section 5.1 of this report defines which sections of the TPIF may be designed, procured, and constructed by the Interconnection Customer should they decide to exercise their ‘Option to Build’.

### 5.1 Transmission Provider’s Interconnection Facilities Suitable for Interconnection Customer Design and Construction

NSPI agrees that the following IR-597 TPIF may be designed and constructed by the Interconnection Customer in accordance with Article 5.1.3 of the Standard Generator Interconnection and Operating Agreement:

- The portion of the new transmission line L-6554 that does not cross any of the existing NSPI transmission or distribution lines or is not in close proximity to existing energized lines.

---

# Facilities Study Report

IR 597 – 36 MW Wind Farm – Mersey Wind Phase 1

---



## 5.2 Transmission Provider's Interconnection Facilities Not Suitable for Interconnection Customer Design and Construction

The following IR-597 TPIF will be designed and constructed by the Transmission Provider in accordance with Article 5.1.3 of the Standard Generator Interconnection and Operating Agreement:

- The modifications to the 50W-Milton Substation.
- The transmission line approaches and locations near the 50W-Milton Substation, and any section of the new transmission line L-6554 that crosses, or is in close proximity to, existing energized lines.
- The telecommunications system including the SCADA RTU.
- The protection and control design associated with the modifications at 50W-Milton and the NSPI protection relays at 112W-Milton Wind.
- The revenue meter, L-6554 protection and control equipment, remote terminal unit (RTU), and telecommunications equipment required at 112W-Mersey Wind substation.

Interfaces and commissioning activities requiring joint collaboration shall be identified during the detail design phase and prior to construction.

## 5.3 Interconnection Customers Interconnection Facilities (ICIF)

The following IR-597 ICIF will be designed and constructed by the Interconnection Customer in accordance with Article 5.10 of the Standard Generator Interconnection and Operating Agreement:

- All elements of the Mersey Wind substation 112W except for provision of the revenue meter and the required L-6554 protection and control equipment, remote terminal unit (RTU), and telecommunications equipment required at 112W-Mersey Wind substation.

---

# Facilities Study Report

IR 597 – 36 MW Wind Farm – Mersey Wind Phase 1

---



## 6.0 SCHEDULE

The Interconnection Customer’s proposed commercial operation date noted in the Facilities Study Agreement was December 15, 2023. NSPI were notified on February 21, 2023 that the targeted commercial operation date had changed to June 30, 2024. Based on estimated timelines for detailed design, procurement, and construction, the proposed commercial operation date cannot be met by NSPI. Preliminary schedule expectations for design, procurement, and construction activities would indicate an in-service date by Q4, 2024.

A preliminary project schedule outlining major components is provided in Appendix G.

A series of milestone target dates (listed below) were assumed based on optimistic but achievable timelines for the purpose of drafting a schedule for this Facilities Study. The in-service dates provided in this schedule are based on achieving these milestones. Missing any of these milestones increases the risk to meeting the projected commercial operation date.

Facilities Study Complete	End of Q1, 2023
Generation Interconnection Agreement Executed	May, 2023
Availability of Line Route Survey Data	Q3, 2023
Detailed Design Start	Q3, 2023
Procurement of Equipment and Material Start	Q3, 2023
L-6554 Right of Way Tree Clearing Complete	Q1, 2024
50W Substation Modifications Complete	Q3, 2024
L-6554 Construction Complete	Q4, 2024

---

# Facilities Study Report

IR 597 – 36 MW Wind Farm – Mersey Wind Phase 1

---



## 7.0 COST ESTIMATE

The cost estimates shown below have been produced using 2022 budgetary rates. They do not include allowance for funds during construction (AFUDC) or any escalations due to timing of project execution.

Section 8.3 of the Generation Interconnection Procedure (GIP) states the Transmission Provider shall use reasonable efforts to provide an +/- 10 percent cost estimate. Due to current industry supply chain volatility and the uncertainty with the final transmission line route selection, the cost estimates are based on the conceptual design outlined in this report and should be considered as a class 3 accuracy level (-20% / +30%).

A 10% contingency has also been included in the estimates to capture any potential unforeseen scope changes.

### Cost Estimate Summary:

<b>Interconnection Facility</b>	<b>Estimated Cost</b>
Substation modifications at 50W-Milton Substation and including NSPI Telecommunication and Protection equipment installed at 112W-Mersey Wind Substation	\$1,299,433
Transmission Line L-6554 – Route Option A	\$3,206,526
Transmission Line L-6554 – Route Option B	\$3,602,014
<b>Total with Transmission Line Route Option A</b>	<b>\$4,505,959</b>
<b>Total with Transmission Line Route Option B</b>	<b>\$4,901,447</b>

A further cost estimate breakdown is provided in Appendix F.

As per Article 10.5 of the GIA, the Interconnection Customer will be responsible for Operating and Maintenance Expenses associated with the TPIF.

---

# Facilities Study Report

IR 597 – 36 MW Wind Farm – Mersey Wind Phase 1

---



## 8.0 COMMISSIONING / OPERATIONS

At 50W-Milton substation, NSPI, as the transmission provider, will perform the commissioning of all protection and control, telecommunications, and SCADA modifications as outlined in section 2.0 of this report.

At 112W-Mersey Wind substation, the Interconnection Customer will perform the commissioning on all primary and secondary equipment including the revenue metering voltage and current transformers. The Interconnection Customer and NSPI will perform joint verification of the communications system and terminal equipment between the interconnection substation and NSPI's communication facilities.

Nova Scotia Power's Meter Services team will install and test the revenue metering.

Nova Scotia Power shall require review of:

- the insulation test results of the Customer's 138 kV circuit breaker and 138kV disconnect switch at 112W-Mersey Wind
- the insulation tests of the revenue metering voltage and current transformers.
- the relay settings test results and injection test results associated with the interconnection protection.
- all secondary commissioning and trip test results for all interface protection, control and metering systems that interface to the Nova Scotia Power transmission system.

NSPI shall witness the final trip tests of all interface protection.

These reviews are required to ensure the interconnection substation is ready to be energized and accepted onto the transmission system.



---

# Facilities Study Report

IR 597 – 36 MW Wind Farm – Mersey Wind Phase 1

---



## Appendix A – Interconnection Facilities Study Agreement

GIP Appendix 4 – Interconnection Facilities Study Agreement

### APPENDIX 4 to GIP INTERCONNECTION FACILITIES STUDY AGREEMENT

THIS AGREEMENT is made and entered into this 1st day of December, 2022 by and between Mersey River Wind Inc., a Company organized and existing under the laws of the Province of Nova Scotia, ("Interconnection Customer,") and Nova Scotia Power Inc., a corporation existing under the laws of the Province of Nova Scotia, ("Transmission Provider "). Interconnection Customer and Transmission Provider each may be referred to as a "Party," or collectively as the "Parties."

#### RECITALS

WHEREAS, Interconnection Customer is proposing to develop a Generating Facility or generating capacity addition to an existing Generating Facility consistent with the Interconnection Request # \_\_\_\_\_ submitted by the Interconnection Customer dated \_\_\_\_\_; and

WHEREAS, Interconnection Customer desires to interconnect the Generating Facility with the Transmission System;

WHEREAS, the Transmission Provider has completed an Interconnection System Impact Study (the "System Impact Study") and provided the results of said study to the Interconnection Customer; and

WHEREAS, Interconnection Customer has requested the Transmission Provider to perform an Interconnection Facilities Study to specify and estimate the cost of the equipment, engineering, procurement and construction work needed to implement the conclusions of the Interconnection System Impact Study in accordance with Good Utility Practice to physically and electrically connect the Generating Facility to the Transmission System.

NSPI Revised Standard Generator Interconnection Procedures, Appendix 4  
As Approved by the UARB February 10, 2010

1

---

# Facilities Study Report

IR 597 – 36 MW Wind Farm – Mersey Wind Phase 1

---



GIP Appendix 4 – Interconnection Facilities Study Agreement

NOW, THEREFORE, in consideration of and subject to the mutual covenants contained herein the Parties agree as follows:

- 1.0 When used in this Agreement, with initial capitalization, the terms specified shall have the meanings indicated in the Transmission Provider's Board-approved GIP.
- 2.0 Interconnection Customer elects and Transmission Provider shall cause an Interconnection Facilities Study consistent with Section 8.0 of this GIP to be performed in accordance with the Tariff.
- 3.0 The scope of the Interconnection Facilities Study shall be subject to the assumptions set forth in Attachment A and the data provided in Attachment B to this Agreement.
- 4.0 The Interconnection Facilities Study report (i) shall provide a description, estimated cost of (consistent with Attachment A), schedule for required facilities to interconnect the Generating Facility to the Transmission System and (ii) shall address the short circuit, instability, and power flow issues identified in the Interconnection System Impact Study.
- 5.0 The Interconnection Customer shall provide a deposit for the performance of the Interconnection Facilities Study as follows.

<u>Project Capacity:</u>	<u>Facilities Study Deposit plus Re-Study Deposit</u>		
Does not exceed 20 MW:	\$ 25,000	plus	\$25,000
Exceeds 20 MW but does not exceed 150MW:	\$ 50,000	plus	\$50,000
Exceeds 150 MW:	\$ 75,000	plus	\$75,000

The time for completion of the Interconnection Facilities Study is specified in Attachment A.

---

# Facilities Study Report

IR 597 – 36 MW Wind Farm – Mersey Wind Phase 1

---



## GIP Appendix 4 – Interconnection Facilities Study Agreement

Upon receipt of the Interconnection Facilities Study, Transmission Provider shall charge and Interconnection Customer shall pay the actual costs of the Interconnection Facilities Study.

The Transmission Provider shall continue to hold the amounts or security on deposit until settlement of the final invoice. In the event the Interconnection Customer fails to pay the final invoice in full when due, the Transmission Provider may apply the amounts or security on deposit against the total amount of the invoice then outstanding.

- 6.0 Miscellaneous. The Interconnection Facility Study Agreement shall incorporate by reference the following Articles of the Standard Generator Interconnection and Operating Agreement: 15.1, 15.2, 15.3, 19, 20, 21, 22, 26, 27, 28 and 30.

---

# Facilities Study Report

IR 597 – 36 MW Wind Farm – Mersey Wind Phase 1

---



GIP Appendix 4 – Interconnection Facilities Study Agreement

IN WITNESS WHEREOF, the Parties have caused this Agreement to be duly executed by their duly authorized officers or agents on the day and year first above written.

**Nova Scotia Power Inc. (Transmission Provider)**

By:  By: \_\_\_\_\_  
Title: Sr. Director T&D operations Title: \_\_\_\_\_  
Date: Dec 1, 2022 Date: \_\_\_\_\_

Mersey River Wind Inc. (Interconnection Customer)

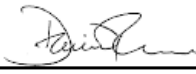
By: Daniel Roscoe   
Title: President  
Date: November 18th, 2022

---

# Facilities Study Report

IR 597 – 36 MW Wind Farm – Mersey Wind Phase 1

---



GIP Appendix 4 – Interconnection Facilities Study Agreement

**Attachment A  
To Appendix 4  
Interconnection Facilities  
Study Agreement**

**INTERCONNECTION CUSTOMER SCHEDULE ELECTION FOR CONDUCTING  
THE INTERCONNECTION FACILITIES STUDY**

The Transmission Provider shall use Reasonable Efforts to complete the study and issue a draft Interconnection Facilities Study report to the Interconnection Customer within the following number of days after Facilities Study commencement date:

- one hundred twenty Calendar Days with no more than a +/- 10 percent cost estimate contained in the report.

---

# Facilities Study Report

IR 597 – 36 MW Wind Farm – Mersey Wind Phase 1

---



GIP Appendix 4 – Interconnection Facilities Study Agreement

**Attachment B (page 1)**  
**Appendix 4**  
**Interconnection Facilities**  
**Study Agreement**

**DATA FORM TO BE PROVIDED BY INTERCONNECTION CUSTOMER WITH THE  
INTERCONNECTION FACILITIES STUDY AGREEMENT**

Provide location plan and simplified one-line diagram of the plant and station facilities. For staged projects, please indicate future generation, transmission circuits, etc.

One set of metering is required for each generation connection to the new ring bus or existing Transmission Provider station. Number of generation connections: \_\_\_\_\_

On the one line indicate the generation capacity attached at each metering location. (Maximum load on CT/PT)

On the one line indicate the location of auxiliary power. (Minimum load on CT/PT) Amps

Will an alternate source of auxiliary power be available during CT/PT maintenance?

Yes       No

Will a transfer bus on the generation side of the metering require that each meter set be designed for the total plant generation?

Yes       No      (Please indicate on one line).

What type of control system or PLC will be located at the Interconnection Customer's Generating Facility? \_\_\_\_\_

NSPI Revised Standard Generator Interconnection Procedures, Appendix 4  
As Approved by the UARB February 10, 2010

6

---

# Facilities Study Report

IR 597 – 36 MW Wind Farm – Mersey Wind Phase 1

---



GIP Appendix 4 – Interconnection Facilities Study Agreement

What protocol does the control system or PLC use? \_\_\_\_\_  
\_\_\_\_\_

Please provide a 7.5-minute quadrangle of the site. Sketch the plant, station, transmission line, and property line.

Physical dimensions of the proposed interconnection station: \_\_\_\_\_

Bus length from generation to interconnection station: Two circuits of 6,600m and 4,220m for a total of 10,800m will connect to the project substation

Line length from interconnection station to Transmission Provider's transmission line.  
6,750m

Tower number observed in the field. (Painted on tower leg)\*: \_\_\_\_\_

Number of third party easements required for transmission lines\*: \_\_\_\_\_  
Two private easements, 1 crown easement, over multiple parcels

\* To be completed in coordination with Transmission Provider.

Is the Generating Facility in the Transmission Provider's service area?

     Yes         No    Local provider: \_\_\_\_\_

---

# Facilities Study Report

IR 597 – 36 MW Wind Farm – Mersey Wind Phase 1

---



GIP Appendix 4 – Interconnection Facilities Study Agreement

Please provide proposed schedule dates:

Begin Construction	Date: <u>March 1, 2023</u>
Generator step-up transformer receives back feed power	Date: <u>August 31, 2023</u>
Generation Testing	Date: <u>December 1, 2023</u>
Commercial Operation	Date: <u>December 15, 2023</u>



# Facilities Study Report

IR 597 – 36 MW Wind Farm – Mersey Wind Phase 1



## Appendix B – Interconnection Overview Diagram

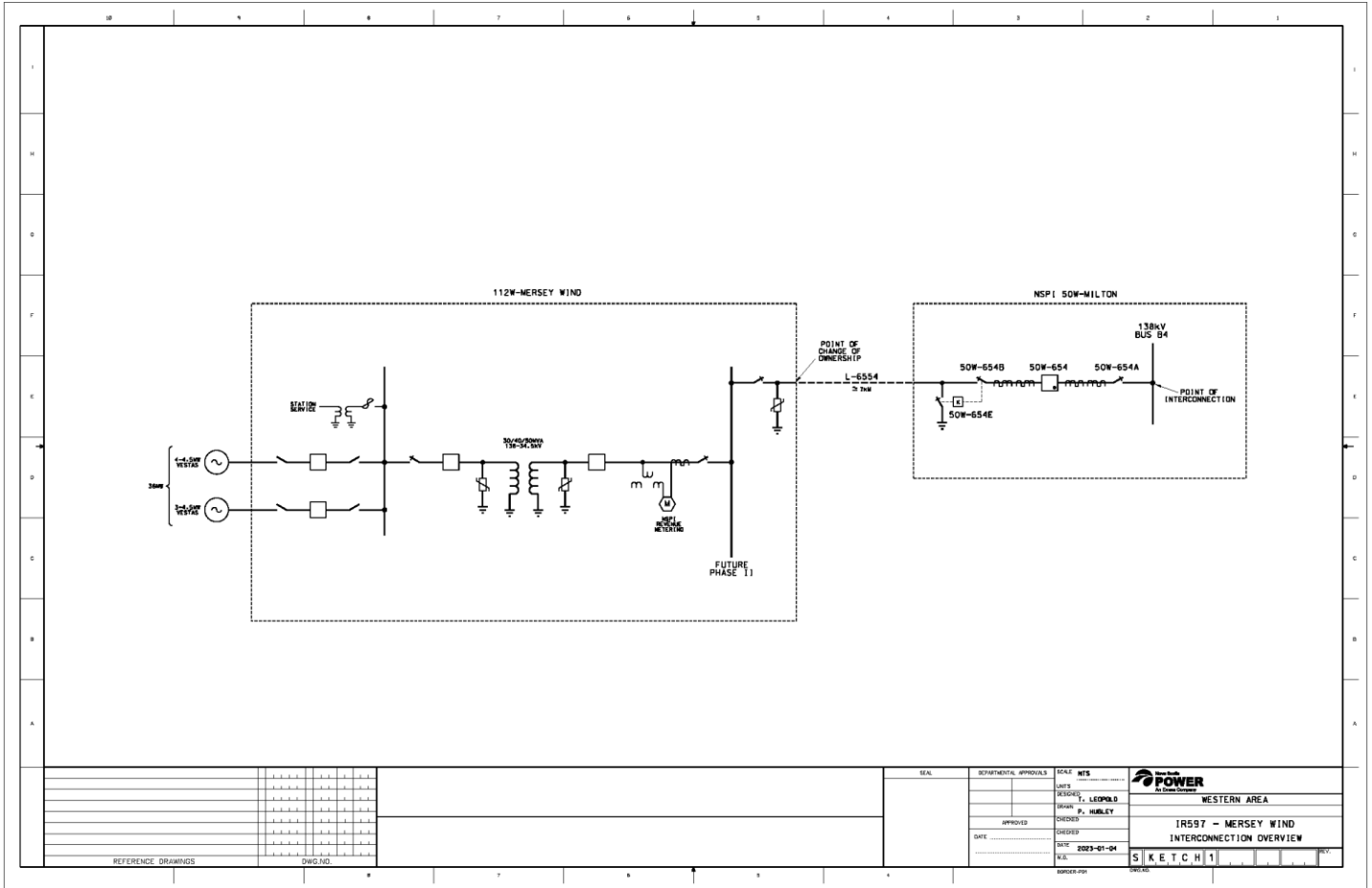

REFERENCE DRAWINGS	DWG. NO.	SCALE	NTS	DESIGNED BY	T. LEOPOLD	DESIGNED BY	F. HUBLEY	DATE	2023-01-04	NO.	5   K E T C H 1
				APPROVED BY						S   K E T C H 1	
				CHECKED BY						S   K E T C H 1	
				DATE						S   K E T C H 1	
				NO.						S   K E T C H 1	



# Facilities Study Report

IR 597 – 36 MW Wind Farm – Mersey Wind Phase 1



## Appendix C-2 50W-Milton Developmental Plan View

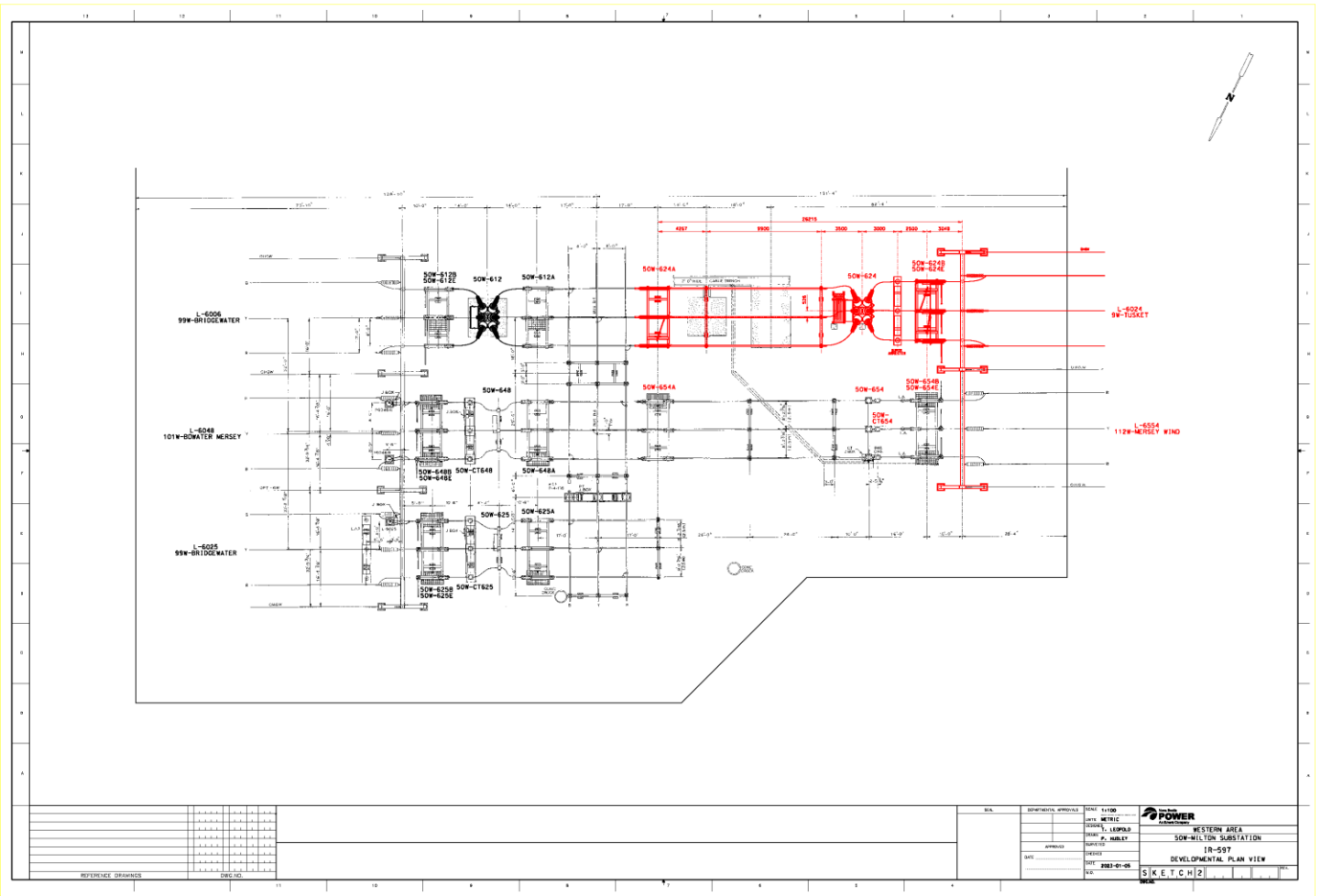

# Facilities Study Report

IR 597 – 36 MW Wind Farm – Mersey Wind Phase 1



## Appendix D – Interconnection Customer Substation One Line

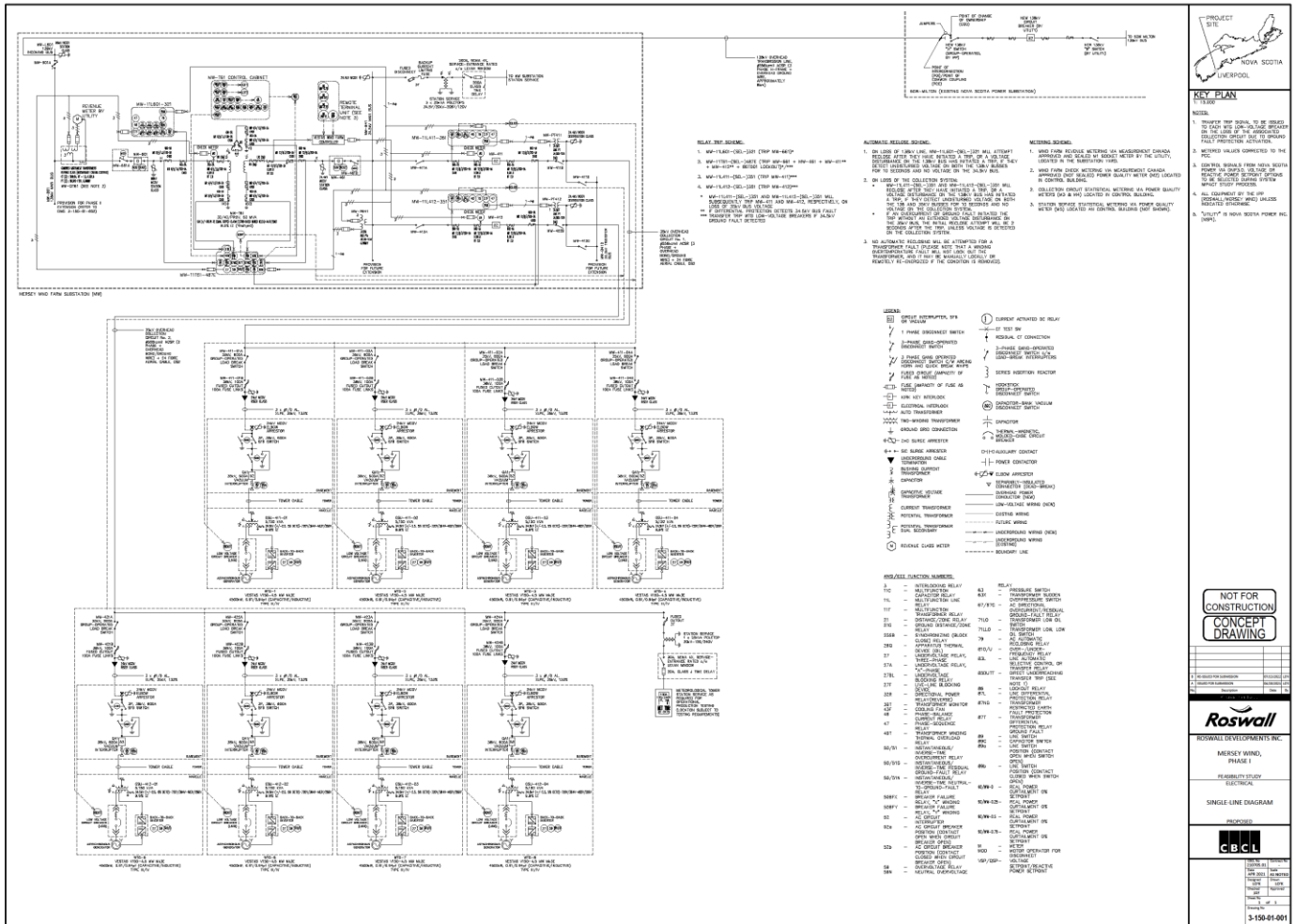

# Facilities Study Report

IR 597 – 36 MW Wind Farm – Mersey Wind Phase 1



## Appendix E – Transmission Line Route Options

Appendix E-1 Customer Proposed Route Option:

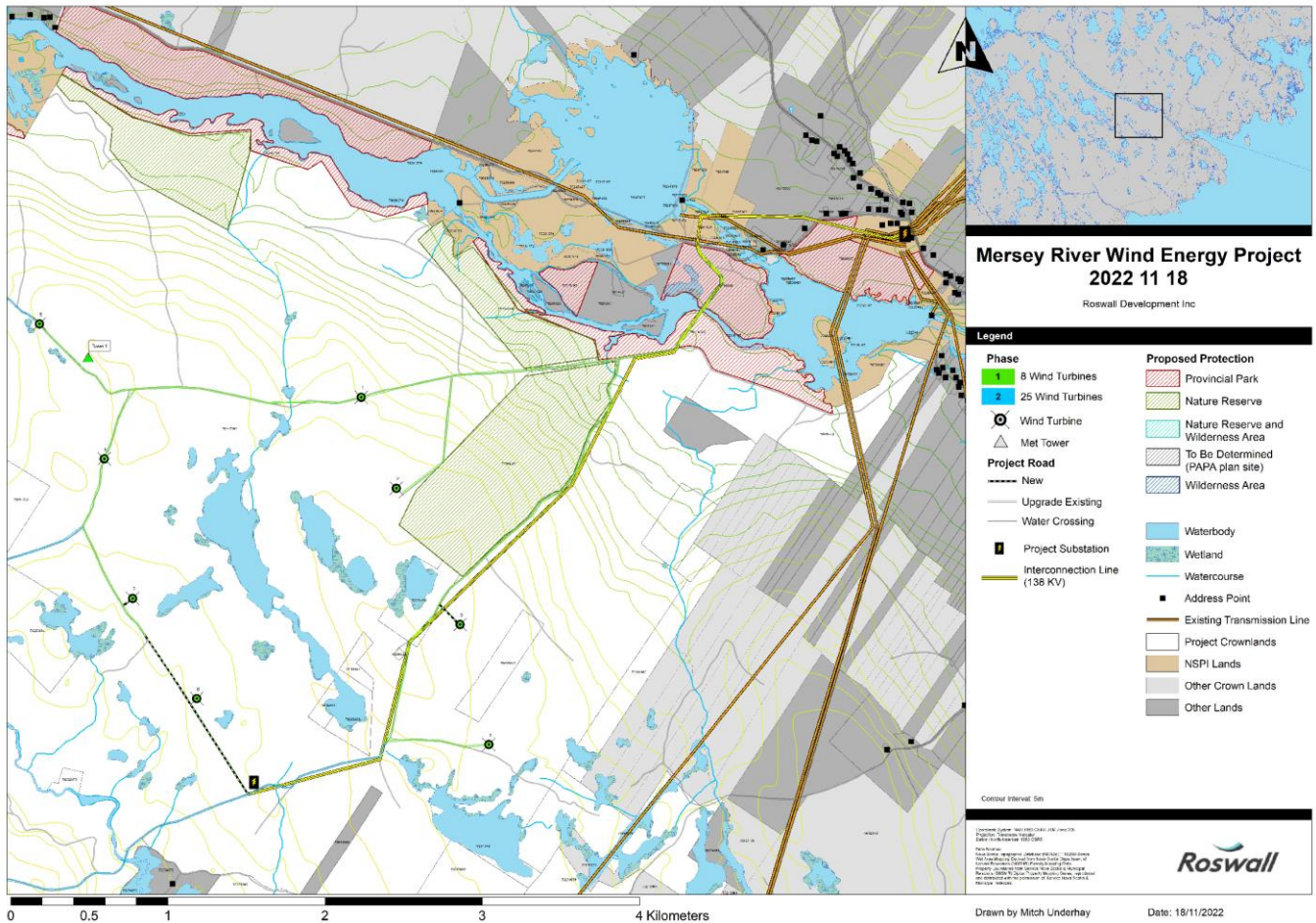

# Facilities Study Report

IR 597 – 36 MW Wind Farm – Mersey Wind Phase 1



Appendix E-1 Alternate Route Option:

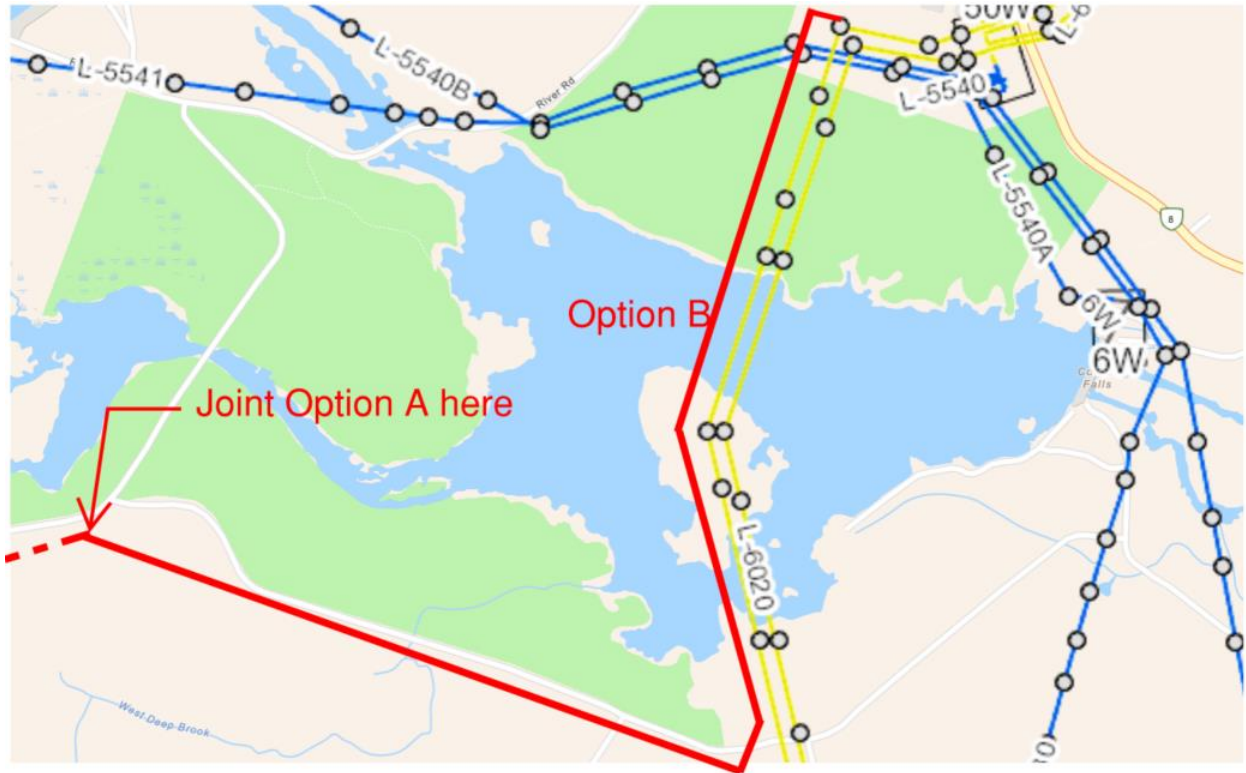

# Facilities Study Report

IR 597 – 36 MW Wind Farm – Mersey Wind Phase 1

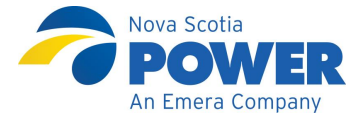

## Appendix F – Cost Estimates

### Substation Modifications:

IR 597 Facilities Study Estimate - Substation Scope Only		CI Number:		Project Number:		IR 597		Cost Centre:		900									
Activity	Accounts -->	535050	535200	531400	530950	533410	533400	531550	532500	Labour	Material	Expenses	Contracts	Consulting	Totals				
003	Buildings, Structures and Grounds	0	0	110,800	0	0	0	128,500							239,300				
022	Electrical Control Equipment	56,723	0	242,000	0	1,500	0	0							300,223				
023	Power Equipment - Station Service	0	0	0	0	0	0	0							0				
043	Substation Devices	33,518	10,313	168,740	0	0	0	0							212,571				
061	Telephone Equipment ( / Comm Equip.)	10,313	0	0	0	150	100	0							10,563				
085	Design (i.e. Engineering)	90,330		2,000	740		500	0					0		93,570				
086	Commissioning	14,335	5,157	0	0	0	0	0							19,492				
087	Field Supervision and Operations	0	0	0	23,220		7,500	60,000							90,720				
088	Survey and Mapping	2,578		0	0		0	0					0	0	2,578				
	<b>Sub-Total</b>	<b>207,798</b>	<b>15,470</b>	<b>523,540</b>	<b>740</b>	<b>1,650</b>	<b>600</b>	<b>188,500</b>	<b>0</b>						<b>938,298</b>				
085	Contingency	20,780	1,547	52,354	74	165	60	18,850	0						93,830				
	<b>Sub-Total</b>	<b>228,578</b>	<b>17,017</b>	<b>575,894</b>	<b>814</b>	<b>1,815</b>	<b>660</b>	<b>207,350</b>	<b>0</b>						<b>1,032,128</b>				
005	Vehicle Allocation (Labour & Eng'g)				83,308										83,308				
005	Construction Overhead (Labour)							150,809							150,809				
005	Construction Overhead (Contracts)							33,189							33,189				
	<b>Sub-Total</b>				<b>83,308</b>			<b>183,998</b>							<b>267,306</b>				
	<b>Grand Total</b>	<b>228,578</b>	<b>17,017</b>	<b>575,894</b>	<b>84,122</b>	<b>1,815</b>	<b>660</b>	<b>391,348</b>	<b>0</b>						<b>1,299,433</b>				

### Transmission Line (Route Option A):

IR 597 Facilities Study Estimate - Transmission Line only (Option CI Number:		Option A		Project Number:		IR 597		Cost Centre:		900									
Activity	Accounts -->	535050	535200	531400	530950	533410	533400	531550	532500	Labour	Material	Expenses	Contracts	Consulting	Totals				
035	Wood Poles	0	0	884,000	0	0	0	1,440,500							2,324,500				
085	Design (i.e. Engineering)	12,787		0	740		500	0	200,000						214,027				
087	Field Supervision and Operations	0	0	0	1,850		7,500	60,000							69,350				
088	Survey and Mapping	2,578		0	0		0	50,000	0						52,578				
	<b>Sub-Total</b>	<b>15,365</b>	<b>0</b>	<b>884,000</b>	<b>740</b>	<b>0</b>	<b>500</b>	<b>1,550,500</b>	<b>200,000</b>						<b>2,651,105</b>				
085	Contingency	1,537	0	88,400	74	0	50	155,050	20,000						265,111				
	<b>Sub-Total</b>	<b>16,902</b>	<b>0</b>	<b>972,400</b>	<b>814</b>	<b>0</b>	<b>550</b>	<b>1,705,550</b>	<b>220,000</b>						<b>2,916,216</b>				
005	Vehicle Allocation (Labour & Eng'g)				6,160										6,160				
005	Construction Overhead (Labour)							11,151							11,151				
005	Construction Overhead (Contracts)							272,998							272,998				
	<b>Sub-Total</b>				<b>6,160</b>			<b>284,150</b>							<b>290,310</b>				
	<b>Grand Total</b>	<b>16,902</b>	<b>0</b>	<b>972,400</b>	<b>6,974</b>	<b>0</b>	<b>550</b>	<b>1,989,700</b>	<b>220,000</b>						<b>3,206,526</b>				

# Facilities Study Report

IR 597 – 36 MW Wind Farm – Mersey Wind Phase 1



## Transmission Line (Route Option B):

IR 597 Facilities Study Estimate - Transmission Line only (Option B)										
Option B										
Project Number: IR 597										
Cost Centre: 900										
		Labour		Material	Expenses			Contracts	Consulting	Totals
Activity	Accounts -->	535050	535200	531400	530950	533410	533400	531550	532500	
035	Wood Poles	0	0	971,500	0	0	0	1,675,000		2,646,500
085	Design (i.e. Engineering)	12,787		0	740		500	0	200,000	214,027
087	Field Supervision and Operations	0	0	0	1,850		7,500	60,000		69,350
088	Survey and Mapping	2,578		0	0		0	50,000	0	52,578
	<b>Sub-Total</b>	<b>15,365</b>	<b>0</b>	<b>971,500</b>	<b>740</b>	<b>0</b>	<b>500</b>	<b>1,785,000</b>	<b>200,000</b>	<b>2,973,105</b>
085	Contingency	1,537	0	97,150	74	0	50	178,500	20,000	297,311
	<b>Sub-Total</b>	<b>16,902</b>	<b>0</b>	<b>1,068,650</b>	<b>814</b>	<b>0</b>	<b>550</b>	<b>1,963,500</b>	<b>220,000</b>	<b>3,270,416</b>
005	Vehicle Allocation (Labour & Eng'g)				6,160					6,160
005	Construction Overhead (Labour)							11,151		11,151
005	Construction Overhead (Contracts)							314,287		314,287
	<b>Sub-Total</b>				<b>6,160</b>			<b>325,438</b>		<b>331,598</b>
	<b>Grand Total</b>	<b>16,902</b>	<b>0</b>	<b>1,068,650</b>	<b>6,974</b>	<b>0</b>	<b>550</b>	<b>2,288,938</b>	<b>220,000</b>	<b>3,602,014</b>



# Facilities Study Report

IR 597 – 36 MW Wind Farm – Mersey Wind Phase 1



## Appendix G – Preliminary Project Schedule

IR 597 Generation Interconnection - Preliminary Schedule																									
Activity	mont	Q1 2023			Q2 2023			Q3 2023			Q4 2023			Q1 2024			Q2 2024			Q3 2024			Q4 2024		
		1	2	3	4	5	6	7	8	9	10	11	12	13	14	15	16	17	18	19	20	21	22	23	24
<b>Project Initiation</b>																									
Facilities Study		■	■	■																					
Generation Interconnection Agreement In Place					■																				
<b>Land Agreements &amp; Permits</b>																									
NSPI Easement Agreements								■	■	■															
Water Crossing Permits								■	■	■															
<b>50W-Milton Substation Modifications</b>																									
Design								■	■	■	■	■	■	■	■	■	■	■	■						
Procurement								■	■	■	■	■	■	■	■	■	■	■	■						
Construction																									
Civil Works and Foundations																	■	■	■						
Structures and Primary Equipment																				■	■	■			
L-6024 Relocation to new bus node																							■	■	■
Commissioning																									
In-Service Target																									
<b>Transmission Line L-6554</b>																									
Design								■	■	■	■	■	■	■	■	■									
Procurement								■	■	■	■	■	■	■	■	■									
Construction																									
Clearing														■	■	■	■	■	■	■	■	■			
Structures and Conductor Stringing														■	■	■	■	■	■	■	■	■			
In-Service Target																									
<b>Customer Substation 112W-Mersey Wind</b>																									
NSPI P&C and Comms. Equip								■	■	■	■	■	■	■	■	■	■	■	■						
Design								■	■	■	■	■	■	■	■	■	■	■	■						
Procure								■	■	■	■	■	■	■	■	■	■	■	■						
Installation																				■	■	■			
Revenue Meter Install																							■	■	■
Substation In-Service Target																									
<b>Commissioning</b>																									
																							■	■	■

# Facilities Study Report

IR 597 – 36 MW Wind Farm – Mersey Wind Phase 1



## Appendix H – Revenue Metering

NSPI Standards 5.7 and 5.12

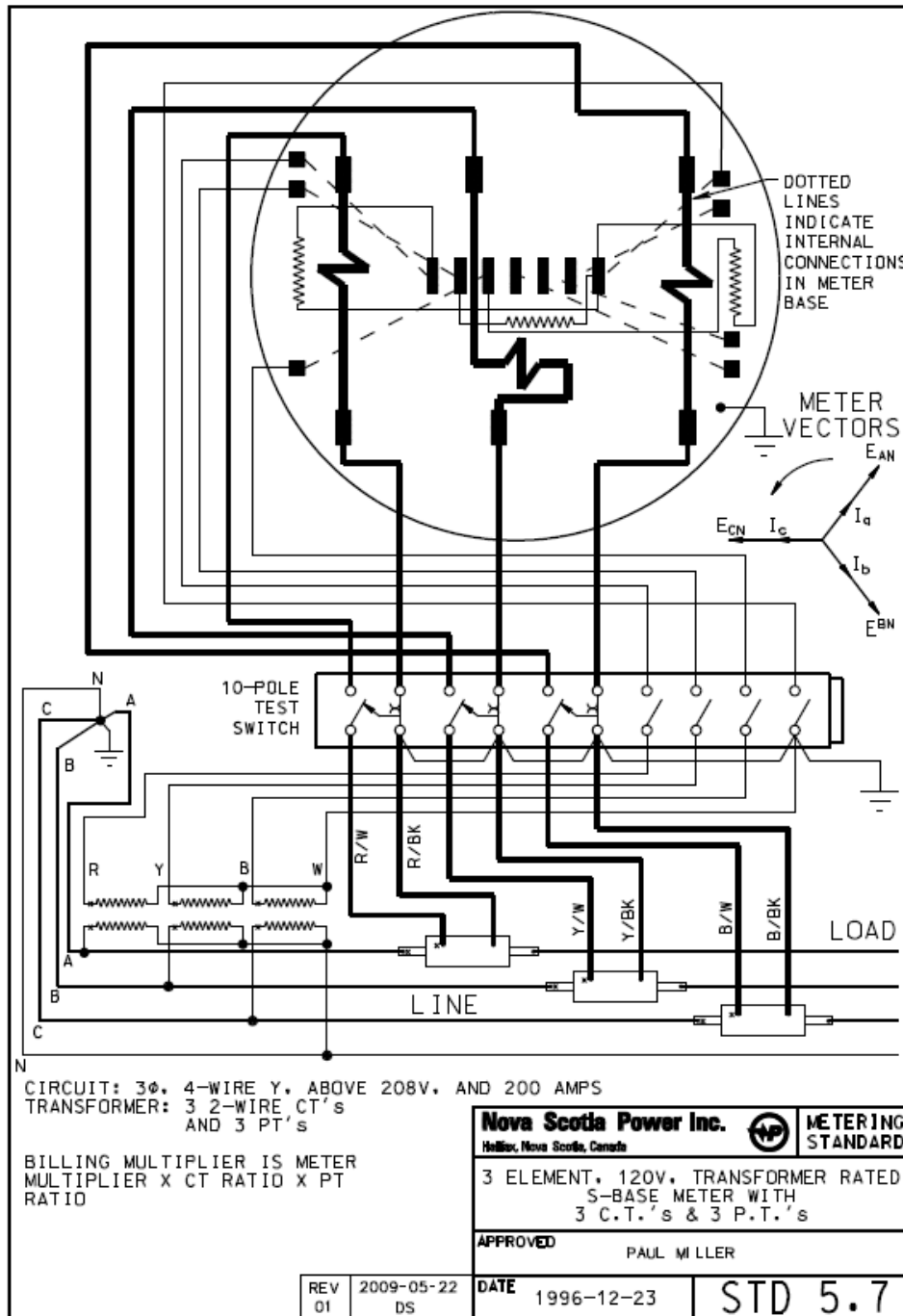

# Facilities Study Report

IR 597 – 36 MW Wind Farm – Mersey Wind Phase 1

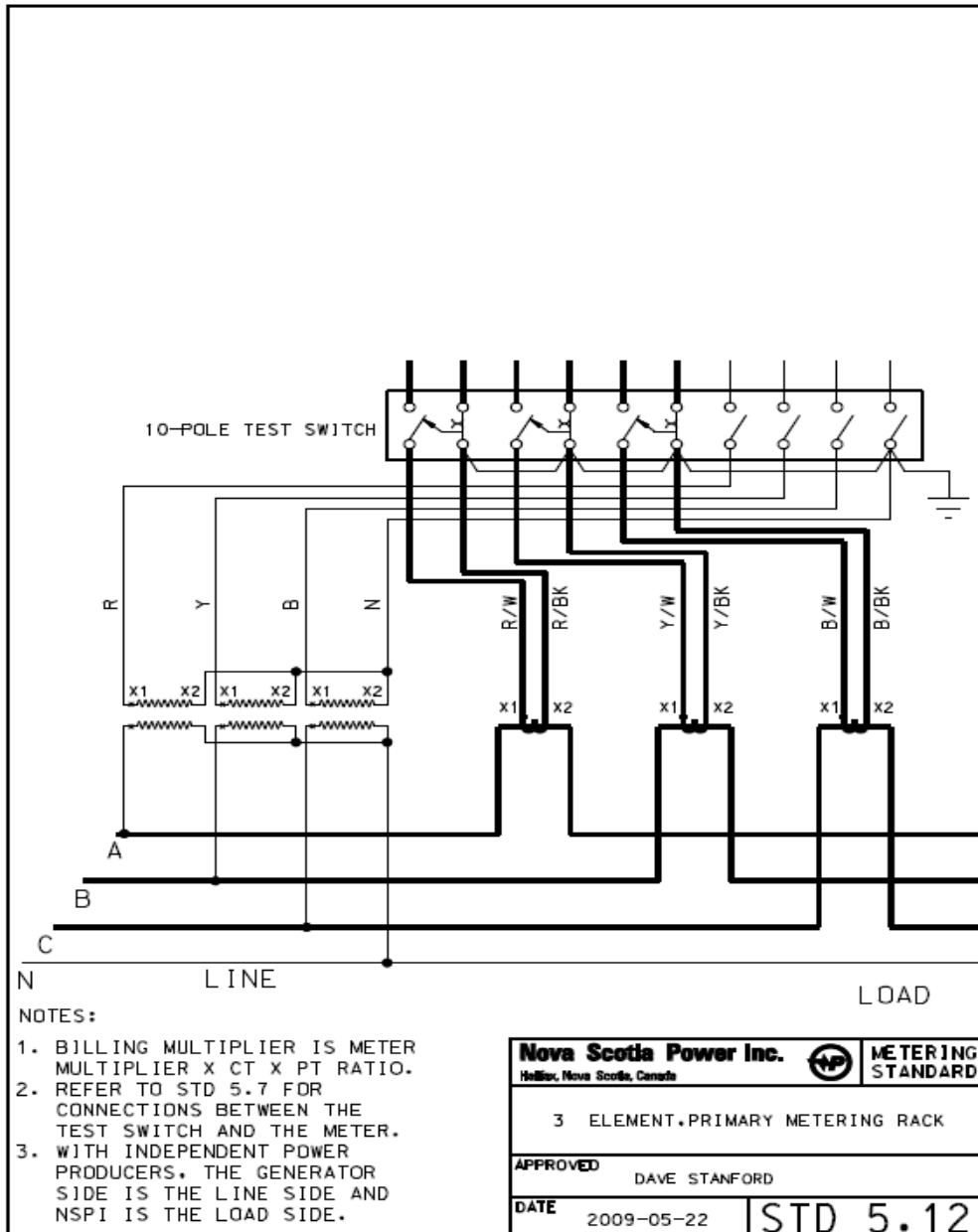

# Facilities Study Report

IR 597 – 36 MW Wind Farm – Mersey Wind Phase 1



## Appendix I – 112W-Mersey Wind SCADA Points List

Note: SCADA points will be finalized after detailed design.

112W- Mersey Wind SCADA Points		
Control	<b>Binary Outputs</b>	<b>Destination</b>
	PERMIT TO OPERATE DENIED	Comms to WFC
	PERMIT TO OPERATE 33%	Comms to WFC
	PERMIT TO OPERATE 66%	Comms to WFC
	PERMIT TO OPERATE FULL	Comms to WFC
	Control Breaker 112W-661	Hard-wired
	<b>Analogue Outputs</b>	
	Active Power Setpoint	Comms to WFC
Voltage Setpoint	Comms to WFC	
Status	<b>Binary Inputs</b>	<b>Source</b>
	Status of PERMIT TO OPERATE DENIED	Comms from WFC
	Status of PERMIT TO OPERATE 33%	Comms from WFC
	Status of PERMIT TO OPERATE 66%	Comms from WFC
	Status of PERMIT TO OPERATE FULL	Comms from WFC
	Status of breaker 112W-661	Hard-wired
	Status of Collector Circuit Recloser 411	Hard-wired
	Status of Collector Circuit Recloser 412	Hard-wired
	TELEPROTECTION URGENT	Comms from SEL relay
	48 V DC BATTERY VOLTAGE LOW	Comms from SEL relay
	LOCAL CONTROL (only for 112W-661)	Hard-wired
	ISLANDING INTERTRIP	Comms from SEL relay
	BREAKER BACKUP LOCKOUT	Hard-wired
	URGENT	Hard-wired
	SUBSTATION ENTRY (if NSPI have a separate room/entrance)	Hard-wired
PROTECTION/DC FAIL	Hard-wired	
Analog	<b>Analog Inputs</b>	
	112W Net Watts	Comms from XFMR protection, or revenue meter
	112W Net Vars	Comms from XFMR protection, or revenue meter
	112W Volts	Comms from XFMR protection, or revenue meter
	Wind speed	Comms from WFC
	Wind direction	Comms from WFC
	Ambient Temperature	Comms from WFC
	Active Power Setpoint confirmation	Comms from WFC
Expected Wind Output for AGC	Comms from WFC	
<b>Added at 50W</b>		
	Control Breaker 50W-654	Hard-wired
	Status Breaker 50W-654	Hard-wired

---

# Facilities Study Report

IR 597 – 36 MW Wind Farm – Mersey Wind Phase 1

---



## Appendix J – Minutes of Facilities Study Review Meeting

Date: March 10, 2023

Attendees: Dan Roscoe, Sandy Peddle, Tim Leopold (NSPI)

### Interconnection Customer (IC) Comments/Questions

1. The IC inquired about the schedule provided in the FAC Report (NSP schedule does not meet IC targeted in-service date)
  - a. NSPI advised that primary driver of schedule was confirmation on final transmission line route and the uncertainty surrounding availability of wood poles and transmission line material.
  - b. IC advised there may be some opportunity to advance survey data required once route finalized.
  - c. IC was advised of options associated with self-performing on Non-Stand-Alone upgrades identified in the FAC as well as the Engineering and Procurement Agreement Option as per Section 9 of the GIP.
  
2. The IC inquired about another possible option to a segment of the Transmission Line route.
  - a. IC was asked to provide a sketch outlining potential route.

### Next Steps:

- Within 30 days of receiving the draft FAC, the IC to provide written comments.
- Within 15 business days of receiving comments on the draft FAC, NSPI will provide the final FAC and draft SSGIA with appendices completed to the extent practical.